

Article number: 01020341

Description: Retaining ring J18 DIN472
Stainless 411

Measures

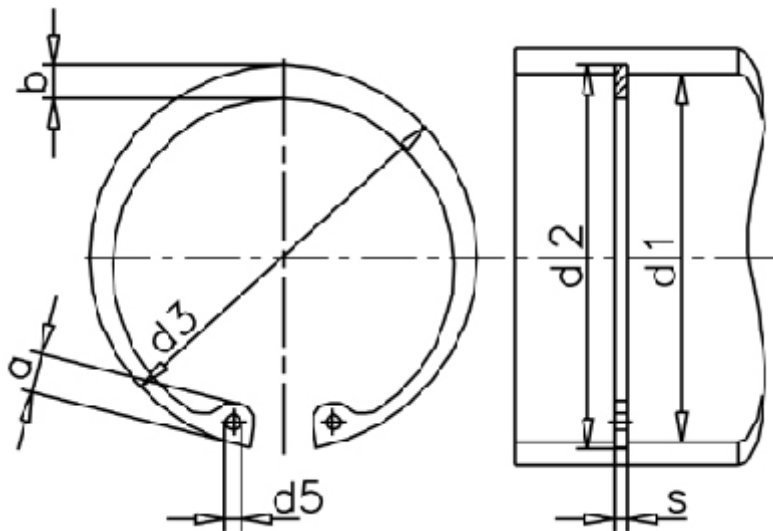

a max	= 4.1	FN kN	= 4.80	t	= 0.50
AN mm ²	= 29.0	FRg kN	= 2.6	tol	= +0,13
b	= 2.2	FR kN	= 6.5	tol	= +0,42-0,13
d1	= 18	g	= 1.0	tol	= -0.06
d2	= 19.0	K kN-mm	= 18.2	Tong	= ZGJ-2
d3	= 19.50	m min	= 1.10	Weight kg/1000	= 0.74
d5 min	= 2.0	Nominal drive	= 1.5		
Description = J 18		s	= 1.00		